

Dimension

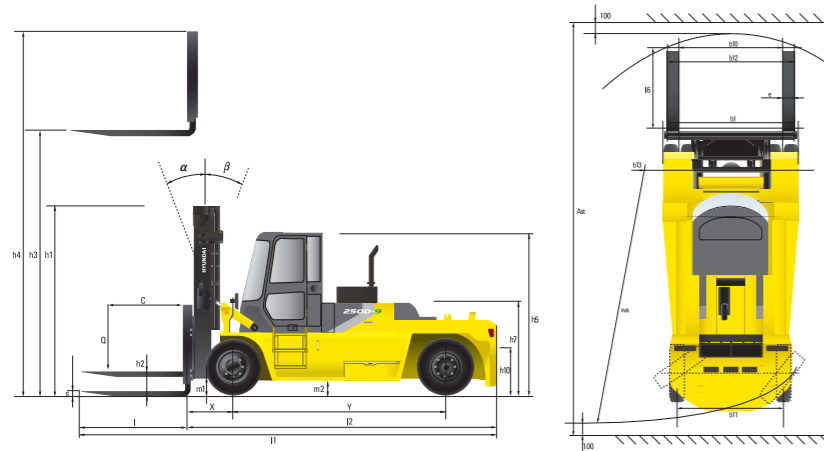

Mast Specification

Mast Type	Maximum Fork Height(in)	Overall Height Lowered(in)	Tilt Angle (deg) Fwd / Bwd	Load Capacity (48in LC) (lb)	Truck Weight Unloaded(lb)
V345	137	141	12 / 10	55,116	80,755
* V400	159	153	12 / 10	55,116	81,617
V450	178	162	12 / 10	55,116	82,168
V500	198	172	12 / 10	55,116	82,731
V550	218	182	12 / 10	55,005	83,308
V600	237	192	12 / 10	55,005	84,611
V650	257	202	12 / 10	53,903	85,288
V700	277	212	12 / 10	51,919	85,910

Load Capacity

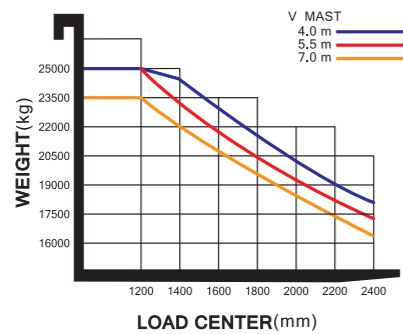

Optional Items

- Fork(L x W x T)(in)
96 x 10 x 4 (STD) / 106 x 10 x 4 / 124 x 10 x 4 / 144 x 10 x 4 / 146 x 10 x 4
- MCV : 6-SPOOL
- INTEGRATED FORK POSITIONER(INDEPENDENT) + SIDE SHIFT(STD)
- AIR COMPRESSOR
- HANDS FREE
- Separator holder type Fork Carriage
- BEACON LAMP

Specification

Identification		
1.1	Manufacturer	HYUNDAI
1.2	Manufacturer's type designation	250D-9
1.3	Drive : electric(battery or mains), diesel, petrol, fuel gas, manual	DIESEL
1.4	Type of operation : hand, pedestrian, standing, seated, order - picker	seated
1.5	Load capacity / rated load	lb 55,116
1.6	Load center distance	c in 47
1.8	Load distance, center of drive axle to fork	x in 44
1.9	Wheelbase	y in 167
Weights		
2.1	Service weight	lb 81,617
2.2	Axle loading, loaded front / rear	lb 126,274 / 92,030
2.3	Axle loading , unloaded front / rear	lb 41,110 / 40,508
Wheels, Chassis		
3.1	Pneumatic	Pneumatic
3.2	Tires size, front(Φ x width)	14.00 - 24 - 32PR
3.3	Tires size, rear(Φ x width)	14.00 - 24 - 32PR
3.5	Wheels, number front rear(x = driven wheels)	4 x 2
3.6	Track width, front	in 87
3.7	Track width, rear	in 84
Basic Dimensions		
4.1	Mast / fork carriage tilt forward / backward	degrees 12 / 10
4.2	Lowered mast height	h1 in 153
4.3	Free lift height	h2 in 0
4.4	Lift height	h3 in 159
4.5	Extended mast height	h4 in 230
4.7	Overhead guard (cab) height	h5 in 127
4.8	Seat height / Standing height	h7 in 85
4.12	Coupling height	h10 in 21
4.19	Overall length	l1 in 347
4.20	Length to face of forks	l2 in 250
4.21	Overall width	b1 in 120
4.22	Fork dimensions	s / e / l in 96 x 10 x 4
4.24	Fork - carriage width	b3 in 116
4.31	Ground clearance, loaded, under mast	m1 in 12
4.32	Ground clearance, centre of wheelbase	m2 in 10
4.33	Aisle width for pallets 1,000 x 1,200 crossways	Ast in 379
4.34	Aisle width for pallets 800 x 1,200 lengthways	Ast in 379
4.35	Turning radius	Wa in 231
4.36	Smallest pivot point distance	in 80
Performance Data		
5.1	Travel speed, unloaded	mph 19.6
5.2	Lift speed, loaded/ unloaded	ft/min 49 / 55
5.3	Lowering speed, loaded/unloaded	ft/min 79 / 59
5.5	Drawbar pull, Loaded	KN 20.5
5.7	Gradient performance, Loaded	% 31.2
5.10	Service brake	Wet, Hydraulic
Engine		
6.1	Engine manufacturer / type	Cummins QSL
6.2	Engine power acc. to ISO 1585	hp 274
6.3	Rated speed	1/min 2,200
6.4	No. of cylinder / cubic capacity	/in³ 543
6.5	Fuel consumption acc. To VDI cycle	ℓ/h 25
Other Details		
8.1	Type of drive control	Power Shift
8.2	Operating pressure for attachments(system/attach)	240 / 160
8.3	Oil volume for attachments	270
8.4	Sound level at driver's ear according to DIN 12 053	76.2

250D-9

Performance Enhanced For Tier-4 Final

MOVING YOU FURTHER

HYUNDAI HEAVY INDUSTRIES



PLEASE CONTACT

www.hceamericas.com

2015. 03 Rev. 0

HYUNDAI FORKLIFT
CONSTRUCTION EQUIPMENT AMERICAS, INC.

6100 Atlantic Blvd Norcross, GA 30071
TEL (678) 823 7777 FAX (678) 823 7778

HYUNDAI
CONSTRUCTION EQUIPMENT AMERICAS, INC.

*Photo may include optional equipment.

Your satisfaction is our priority!

Hyundai introduces a new line of 9-series diesel forklift trucks. The newly designed 4 wheel counterbalance trucks provide every operator comfortable driving, increased productivity and easy maintenance.

New Diesel Forklift with Proven Quality and Advanced Technology

- Maximum performance
- Spacious operator's cab
- Load indicator
- OPSS System for safe operation
- Easy serviceability
- Hi-mate (Remote Management System)



■ Some of the photos may include optional equipment.

High Efficiency & Optimal Performance



Powerful engine and high technology systems provide you with enhanced performance and highest productivity.

250D-9



Cummins QSL Engine

274hp/2,200rpm
897lbft/1,500rpm

Powerful Engine

The six cylinders turbo-charged engine is built for power, reliability and economy. This engine meets EPA Tier 4 and EU stage IV emission regulation.

Variable Geometry Turbo

Unique sliding nozzle design controls EGR flow and boosts response at all engine speeds - avoids the need for twin turbo complexity

New CM2350

Improved microprocessor and memory

Clean Crankcase Filter

Removes crankcase emissions and eliminates oil drips or mist for ultra-clean engine operation

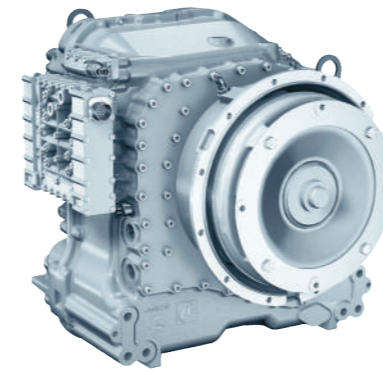

ZF Full-automatic Transmission

Full-automatic transmission gives easy, convenient handling and soft, smooth shifting. The operator can select two kinds of automatic modes.(1st 3rd, 2nd 3rd)
Improved Torque converter with stator free wheel improves fuel efficiency by 4% compared with the previous model.

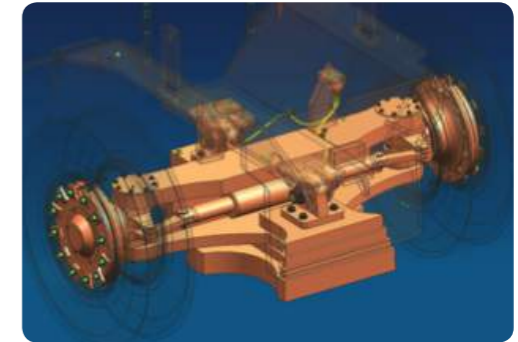

Fully Hydrostatic Power Steering

The hydraulic steering system guarantees smooth and flexible steering, preventing over-run and kick-back.

Load Sensing System

Flow on demand to cylinder creates energy savings. (No excessive flow)

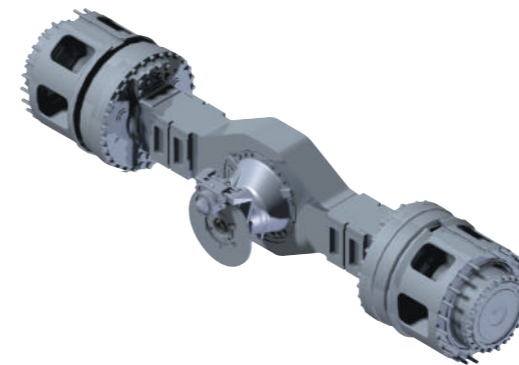

Kessler Durable drive axle

The planetary reduction drive axle smoothly delivers desired torque to the drive wheels.

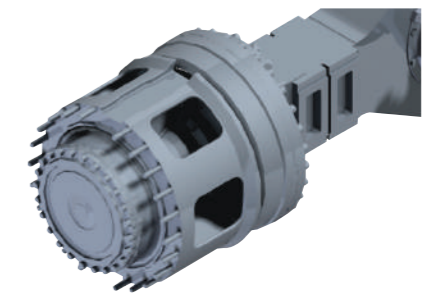

Wet Disc Brake System

The wet disc brake system is virtually maintenance free and is enclosed to protect from dust and water.



Increased mast tilting angle

Utilizing the mast tilting angle of 12 degrees forward and 10 degrees backward, the operator can perform loading and unloading jobs safely and rapidly.



Max.Gradeability (loaded)		Max.Travel Speed (Unloaded)	
Model	%	Model	mph
250D-9	31.2	250D-9	19.6

Faster Travel Speed & Better Gradability

The powerful engine provides dynamic acceleration, excellent gradability and optimal travel speed on tough terrains and slopes.

Best Convenience & Optimized Ergonomics



The ergonomically designed cab provides full support and comfort to the operator.

250D-9



Spacious operator cab

The newly designed cab optimizes space for a wide field of view and operator comfort.

■ Some of the photos may include optional equipment.



Quick Response of Operating Control Levers

Only minimal operator's effort is required for precise, safe and productive control.

(5-Lever, 6-Function : Standard)

(5-Lever, 7-Function : Option)



Ergonomically positioned pedals

Based on human engineering the accelerator, brake and inching pedals are optimally positioned for the operator's convenience.

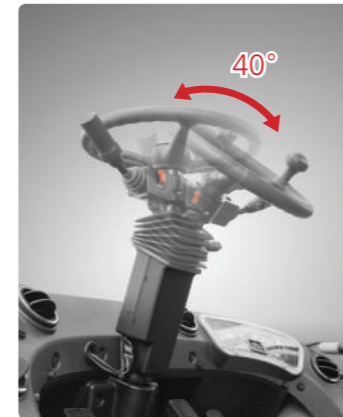

Adjustable steering column

Steering handle is adjustable depending on the operator's body shape. Adjustability of steering column provides infinite settings to meet the comfort level of any operation.



MP3 CD Player & Remote Control



Bluetooth Hands Free Socket (Option)



Centralized Instrument switch Panel



Luxury(Air-suspension+Heat+HeadRest) seat(Option)

An attractive and adjustable seat, based on a human engineering design, provides great comfort, safety and durability.

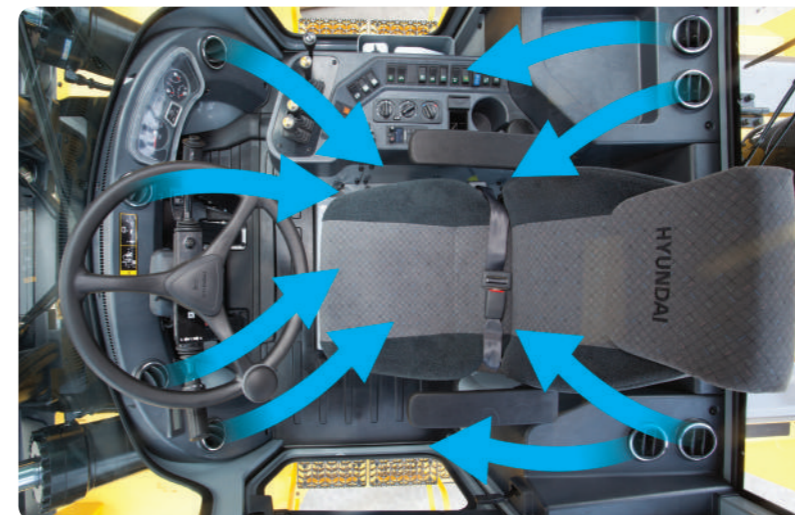

High-output Air Conditioner & Heater

An air conditioner with an integrated condenser is mounted on upper side of the cab to create an open and roomy compartment.

We design all our cabs with high output and multi directional airflow to provide the most comfortable work environment.

Advanced Safety



The safely designed driver's space makes your operating more comfortable.

250D-9



Engine Control Mode

According to operating load, the operator can select engine mode by changing side panel switch.
 STD Mode : Fuel reduction mode for light-duty operating load
 POWER Mode : Heavy-duty or operating at slope



Adjustable Engine Low Idle RPM

While engine runs, idle rpm can be reduced or increased by units of 25rpm and it keeps previously set rpm when engine restarts.

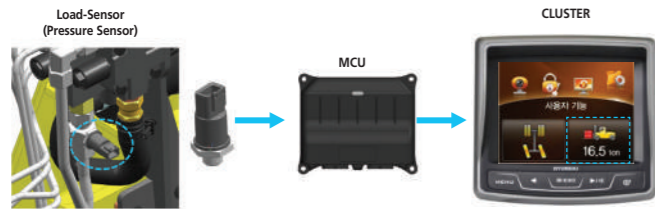

Load indicator

The optional load indicator displays the load weight in the monitor. The load sensor reduces the time to check loaded weight and the alarm alerts the driver when overloaded.

OPSS (Operator Presence Sensing System)

When the operator is not in the seat all mast and drive movements are inoperable.

Lift Lock Tilt Lock Drive Lock



■ Some of the photos may include optional equipment.

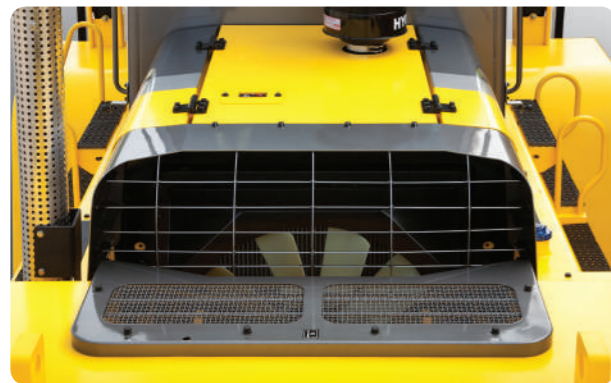

Up-to-date Cooling System

The minimum fuel consumption and low noise are available by applying hydraulic cooling fan sensing intake air temperature, transmission oil temperature, coolant temperature and hydraulic temperature.

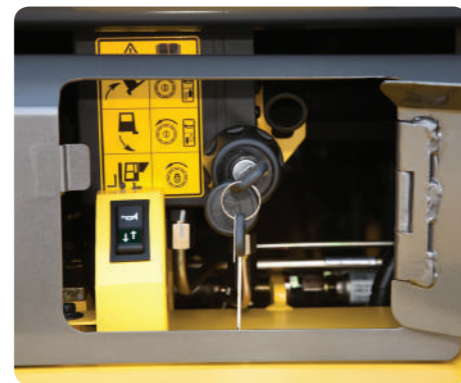

Cab Tilt System

The cab tilt system makes servicing of all power train components quick and easy. An electrically assisted hydraulic actuated cylinder tilts the operator cab to the left side about 65 degrees for easy access to inside of truck components.

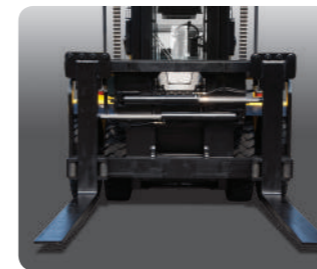

Highly durable Carriage

The carriage is very strong and is constructed with high tensile structural steel which has an excellent durability.



Large footboard & Handle

Wide "open" step offers convenience and safety when entering and exiting the truck.



Excellent Night Work

- Various position of work lamp provides the operator great visibility and a safe operating environment.
 - Front : fender(2), mast(4) - Rear : cab(2)
 - LED Rear Combination Lamp



Fast and Easy Maintenance

250D-9

An ideal arrangement of components ensures easy access and convenience for maintenance.



Large Engine Hood

Highly accessible engine compartment assures fast and efficient maintenance.



Easy Change Air Cleaner
This air filter is readily accessible for cleaning or replacement.

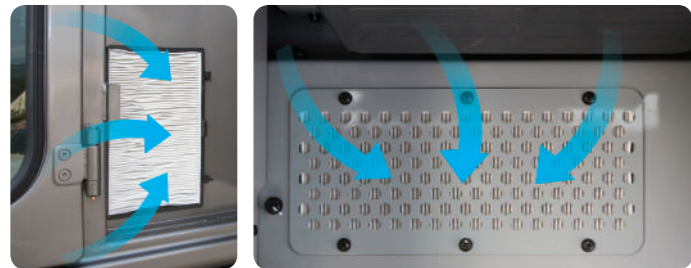

Cabin Air Fresh Filter

The internal pressure is maintained to be slightly higher than that of outside to exclude dust and to reduce noise levels.

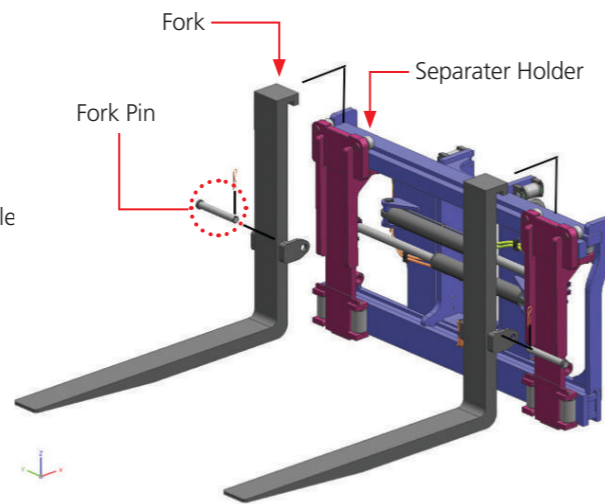

Separator holder type Fork Carriage(Optional)

To improve handling and easily switch forks and other attachment Separator holder system is adopted as option. It is possible to install various attachments like coil ram easily.



Hi-mate (Remote Management System)

Hi-mate, Hyundai's proprietary remote management system, provides operators and dealer service personnel access to vital service and diagnostic information on the machine from any computer with internet access.



Rear View Camera

The rear view camera provides great rear visibility, and the monitor supports 4 camera channels for operator convenience.



*Some of the photos may include optional equipment.



Master Switch

A master switch disconnects the battery power to protect the electrical system from excess electrical drainage.



Maintenance Management Display

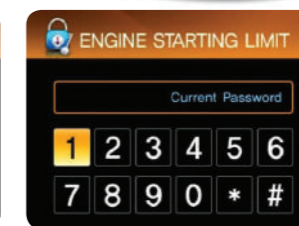

Engine Start Limit